

# ASO: The air flow giant.

At 60 Hz, the ASO delivers 560 cfm. When used with the appropriate accessories it can supply several Leister air heaters in parallel.

## Medium pressure blower

### ASO



#### Technical Data SILENCE

Design: radial blower

Frequency	Hz	50	60
Air flow (68 °F)	cfm	476	560
Static pressure	psi	0.23	0.35
Max ambient temperature	°F	140	140
Max. air inlet temperature	°F	392	392
Noise emission level	dB(A)	70	70
Environmental protection (IEC 60529)		IP 54	IP 54
Outside diameter air inlet	in	∅ 5.28	∅ 5.28
Outside diameter air outlet	in	∅ 3.54	∅ 3.54
Weight	lbs	33.1	33.1
Mark of conformity		CE	CE
Protection class I		⊕	⊕

#### Installation dimensions in inches

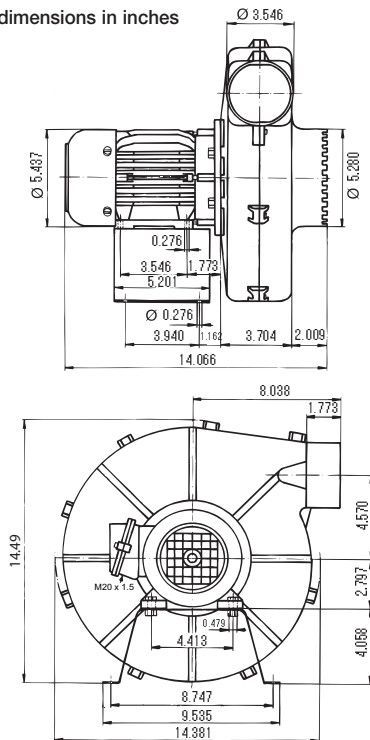

Voltage	V- 50Hz	1 × 230	3 × 230 / 400
	60Hz		3 × 440 – 480
Power consumption	W	550	550
Without cable	Order no.		103.527
9.84 ft cable / Euro plug	Order no.	103.530	



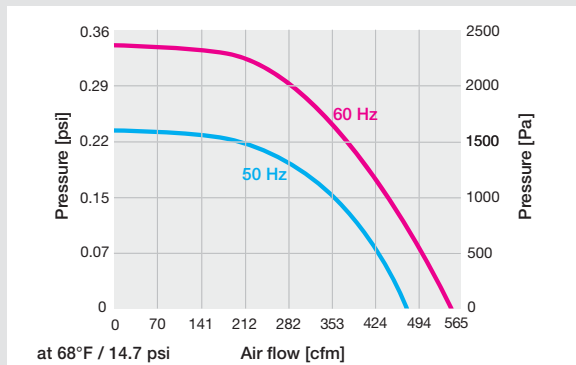



Additional versions available on request

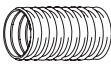

Accessories page 60



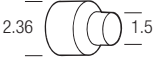
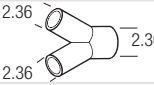
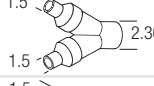

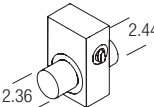
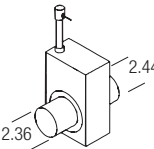
## Accessories SILENCE

(Ø 2.36 in)

107.288		PVC air hose Ø 2.36 in
107.287		Hose clip for Ø 2.36 in air hose
107.240		Closing cap Ø 2.36 in attachable to hose connection adaptor 107.238 and 107.278
107.294		Stainless steel filter, push-fit on air intake
110.887		Motor capacitor 230 V
107.291		Hose connection adaptor with 1 air outlet for Ø 1.5 in hose. Push-fit on air outlet
107.278		Hose connection adaptor, Push-fit on air outlet
107.292		Hose connection adaptor with 2 air outlets for Ø 1.5 in hose. Push-fit on air outlet
107.293		Hose connection adaptor, Push-fit on adaptor 107.292
107.295		Hand operated air flow adjuster and on/off switch. Size 8.43 × 3.46 × 5.24 in
107.296		Air flow off/on switch The air flow is interrupted on command (pneumatic 72.5 psi) to the heaters. Size 8.43 × 3.46 × 5.24 in

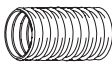

## Accessories ASO

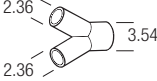
(Ø 3.54 in)

107.237		PVC air hose Ø 3.54 in
107.236		Hose clip for Ø 3.54 in air hose
107.239		Stainless steel filter, push-fit on air intake
111.771		Motor capacitor 230 V
107.238		Hose connection adaptor, Push-fit

## Accessories MONO

(Ø 1.5 in)

133.067		Holder
124.503		External air hose connection adaptor a = 2.52 in, b = 1.5 in
107.288		PVC air hose, Ø 2.36 in

### Special nozzles on request

If using non-Leister blowers or accessories, Leister does not provide any warranty for its products.