

MONO: Compact with high performance.

In spite of its small size, this blower delivers an impressive air volume of 32 cfm and a static pressure of 0.73 psi. With its maintenance-free, brushless motor, it is suitable for used for continuous operation. The compact MONO blower can easily be mounted in confined spaces.

High pressure blower

MONO



Technical data

Frequency	Hz	50 / 60
Air flow (68°F)	cfm	32
Static pressure	psi	0.73
Mains switch		•
Device protection		•
Max. ambient temperature	°F	< 140
Outside diameter air outlet	in	∅ 1.5
Weight with 3 m cable	lbs	2.65
Mark of conformity		CE
Protection classe II		□

Installation dimensions in inches

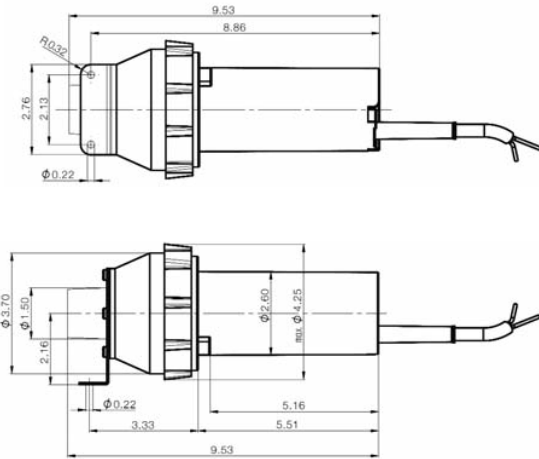



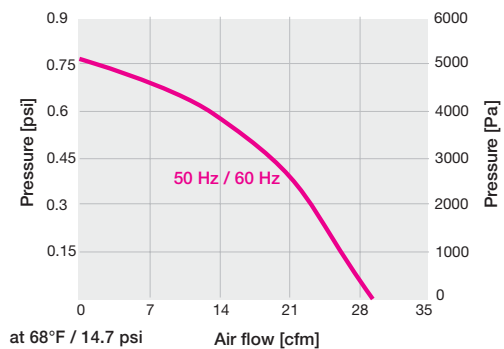



Voltage	V~	230	120
Power consumption	W	230	230
Plug		Euro	US-plug (pol.)
Order no.		132.869	141.041

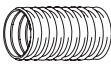

➔ Accessories page 60



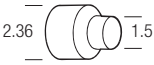
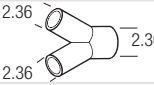
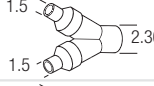

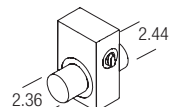
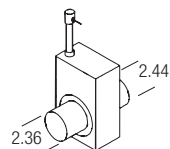
Accessories SILENCE

(Ø 2.36 in)

107.288		PVC air hose Ø 2.36 in
107.287		Hose clip for Ø 2.36 in air hose
107.240		Closing cap Ø 2.36 in attachable to hose connection adaptor 107.238 and 107.278
107.294		Stainless steel filter, push-fit on air intake
110.887		Motor capacitor 230 V
107.291		Hose connection adaptor with 1 air outlet for Ø 1.5 in hose. Push-fit on air outlet
107.278		Hose connection adaptor, Push-fit on air outlet
107.292		Hose connection adaptor with 2 air outlets for Ø 1.5 in hose. Push-fit on air outlet
107.293		Hose connection adaptor, Push-fit on adaptor 107.292
107.295		Hand operated air flow adjuster and on/off switch. Size 8.43 × 3.46 × 5.24 in
107.296		Air flow off/on switch The air flow is interrupted on command (pneumatic 72.5 psi) to the heaters. Size 8.43 × 3.46 × 5.24 in

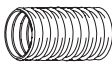

Accessories ASO

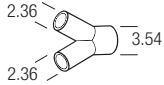
(Ø 3.54 in)

107.237		PVC air hose Ø 3.54 in
107.236		Hose clip for Ø 3.54 in air hose
107.239		Stainless steel filter, push-fit on air intake
111.771		Motor capacitor 230 V
107.238		Hose connection adaptor, Push-fit

Accessories MONO

(Ø 1.5 in)

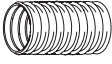
133.067		Holder
124.503		External air hose connection adaptor a = 2.52 in, b = 1.5 in
107.288		PVC air hose, Ø 2.36 in

Special nozzles on request

If using non-Leister blowers or accessories, Leister does not provide any warranty for its products.