



Easy welding with the ergonomic pressure roller.

Hot air tool

TRIAC BT

The TRIAC BT fulfills all of the functionality and design requirements necessary for successful plastic welding. Weighing just 2.2 pounds, it is the lightest in its class and is made from high-quality material. Every TRIAC BT kit undergoes stringent quality inspections before leaving the factory in Switzerland. The sturdy storage case includes everything an expert technician requires.

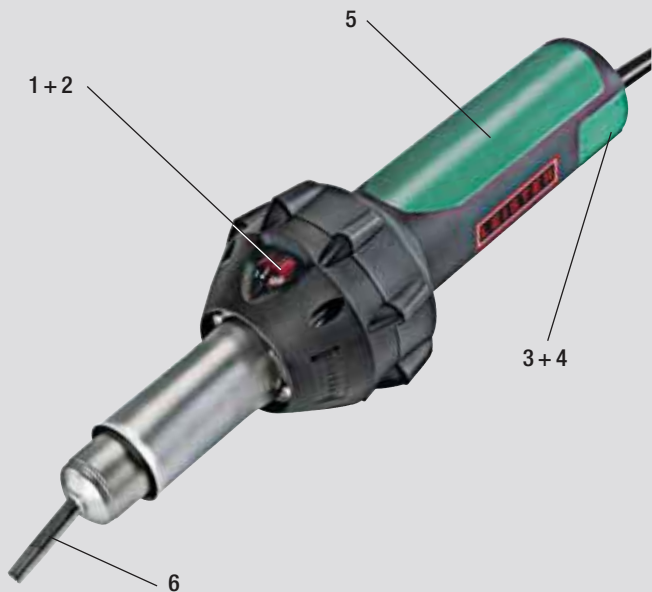

1		Temperature setting: Convenient and reliable temperature adjustment.
2		Accidental start-up protection: The temperature adjustment becomes lit-up if the power to the tool is interrupted.
3		Filter: The fine mesh air filter prevents dirt from clogging the air inlet.
4		Filter cleaning: The air filters on both sides can be easily removed and cleaned.
5		Tool handle: Ergonomically designed handle with a soft grip covering for a secure hold.
6		Nozzle: Extra strong integral 5 mm universal nozzle.
7		Spare heating element: Protected, packed and within easy reach.
8		Storage case: Enough space for all the accessories the professional needs.



Included in delivery



Intuitive design and easy handling for precision welding.



Perfect for detailed work.





Hot air tool

TRIAC BT tarpaulin welding kit

The TRIAC BT tarpaulin welding kit is perfect for the ambitious tarpaulin and billboard specialist.

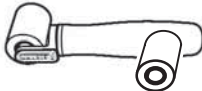
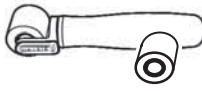
- Light and easy to handle
- Ergonomic handle for welding without strain
- Electronically protected heating element
- Integral precision nozzle
- Built-in start-up protection in the event of power interruption

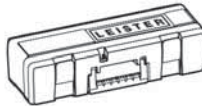
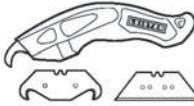
Accessories TRIAC BT

	140.160	Pressure roller 1.6 inch with ball bearings (silicone)
	140.161	Pressure roller 1.1 inch with ball bearings (silicone)
	136.918	Heating element, 120 V / 1500 W
	116.586	Storage case for TRIAC BT, TRIAC PID, TRIAC S, ELECTRON
	137.855	Leister cutter with four blades
	138.902	10 x 10 spare blades hook shape
	138.539	10 x 10 spare blades trapezoid shape

Technical Data

Voltage	V~	120
Power	W	1550
Temperature	°F	68 – 1292
Size (L x Ø)	inch	14.6 x 3.5, handle Ø 2.2
Weight	lbs	2.2 (without 6.5 ft cord)
Conformity Marking	CE	
Approval Mark	E	
Certification Scheme	CCA, CB	
Protection Class II	□	

Article No.:

136.942	TRIAC BT 120 V / 1550 W tarpaulin welding kit 1.6 inch, with US plug
136.941	TRIAC BT 120 V / 1550 W tarpaulin welding kit 0.8 inch, with US plug

Included in delivery: TRIAC BT, spare heating element, pressure roller 1.6 inch, storage case



Included in delivery.



Perfect for hot gas extrusion welding of containers and apparatuses.

Hot air tool

TRIAC BT plastic fabrication kit

The TRIAC BT plastic welding kit is perfect for ambitious plastic fabrication engineers.

- Light and easy to handle
- Ergonomic handle for welding without strain
- Electronically protected heating element
- Integral universal nozzle
- Built-in start-up protection in the event of power interruption

Technical Data







Voltage	V~	120
Power	W	1550
Temperature	°F	68 – 1292
Size (L × Ø)	inch	14.6 × 3.5, handle Ø 2.2
Weight	lbs	2.2 (without 6.5 ft cord)
Conformity Marking	CE	
Approval Mark	E	
Certification Scheme	CCA, CB	
Protection Class II	□	

Article No.:

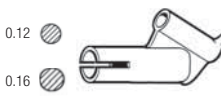
136.943 TRIAC BT 120 V / 1550 W plastic fabrication kit, with US plug

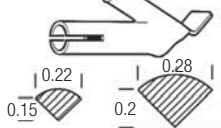
Included in delivery: TRIAC BT, spare heating element, tacking nozzle, speed welding nozzle 0.22 inch (profile A), storage case

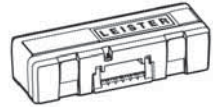
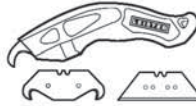
Accessories TRIAC BT

	106.996	Tacking nozzle, push-fit on tabular nozzle, Ø 0.2 inch
	106.989	Speed welding nozzle, push-fit on tabular nozzle, Ø 0.2 inch
	106.990	0.16 inch
	106.991	0.2 inch
	106.992	Speed welding nozzle, push-fit on tabular nozzle, 0.22 inch, profile A
	106.993	Speed welding nozzle, push-fit on tabular nozzle, 0.28 inch, profile B
	136.918	Heating element, 120 V / 1500 W
	116.586	Storage case for TRIAC BT, TRIAC PID, TRIAC S, ELECTRON
	137.855	Leister cutter with four blades
	138.902	10 x 10 spare blades hook shape
	138.539	10 x 10 spare blades trapezoid shape



Included in delivery.



Well balanced design for precise welding of floor coverings.



Hot air tool

TRIAC BT floor welding kit

The TRIAC BT floor welding kit is ideal for the ambitious flooring technician.

- Light and easy to handle
- Ergonomic handle for welding without strain
- Electronically protected heating element
- Integral tabular nozzle 0.2 inch
- Built in start-up protection in the event of power interruption

Technical Data











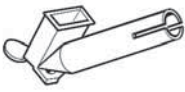

Voltage	V~	120
Power	W	1550
Temperature	°F	68 – 1292
Size (L x Ø)	inch	14.6 x 3.5, handle Ø 2.2
Weight	lbs	2.2 (without 6.5 ft cord)
Conformity Marking	CE	
Approval Mark	S	
Certification Scheme	CCA, CB	
Protection Class II	□	

Article No.:

136.940 TRIAC BT 120 V / 1550 W floor welding kit, with US plug

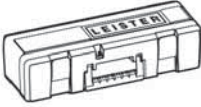
Included in delivery: TRIAC BT, two speed welding nozzles 0.2 inch (one with small air-slide for PUR materials), spare heating element, storage case

Accessories TRIAC BT

	107.139	Speed welding nozzle, 0.18 x 0.5 inch, for fillet weld, push-fit on tabular nozzle Ø 0.2 inch
0.12 	106.989	Speed welding nozzle 0.12 inch, push-fit on tabular nozzle Ø 0.2 inch
0.16 	106.990	Speed welding nozzle 0.16 inch, push-fit on tabular nozzle Ø 0.2 inch
0.2 	106.991	Speed welding nozzle 0.2 inch, push-fit on tabular nozzle Ø 0.2 inch
0.12 	105.431	Speed welding nozzle 0.12 inch with small air-slide, push-fit on tabular nozzle
0.16 	105.432	Speed welding nozzle 0.16 inch with small air-slide, push-fit on tabular nozzle
0.2 	105.433	Speed welding nozzle 0.2 inch with small air-slide, push-fit on tabular nozzle
	136.918	Heating element, 120 V / 1500 W
	116.586	Storage case for TRIAC BT, TRIAC PID, TRIAC S, ELECTRON
	137.855	Leister cutter with four blades
	138.902	10 x 10 spare blades hook shape
	138.539	10 x 10 spare blades trapezoid shape



The hand roller is an essential accessory for tunnel applications.

Hot air tools

General accessories

Roofing

	140.160 Pressure roller 1.6 inch with ball bearings (silicone)
	140.599 5 spare silicones
	140.161 Pressure roller 1.1 inch with ball bearings (silicone)
	140.598 5 spare silicones
	106.974 Pressure roller 3.1 inch (silicone)
	106.972 Pressure roller, with ball bearings (brass)
	106.976 Pressure roller 1.1 inch (PTFE)
	138.314 Seam probe tester
	111.346 Chamfer plane with ten spare blades
	111.348 Spare blades kit containing ten blades
	137.855 Leister cutter with four blades
	138.902 10 x 10 spare blades hook shape
	138.539 10 x 10 spare blades trapezoid shape
	116.586 Storage case, for TRIAC BT, TRIAC PID, TRIAC S, ELECTRON

Billboards / Tarpaulins

	140.160 Pressure roller 1.6 inch with ball bearings (silicone)
	140.599 5 spare silicones
	140.161 Pressure roller 1.1 inch with ball bearings (silicone)
	140.598 5 spare silicones
	106.974 Pressure roller 3.1 inch (silicone)
	106.981 Pressure roller for custom seal
	116.798 Brass brush
	137.855 Leister cutter with four blades
	138.902 10 x 10 spare blades hook shape
	138.539 10 x 10 spare blades trapezoid shape
	116.586 Storage case, for TRIAC BT, TRIAC PID, TRIAC S, ELECTRON



Hot air tools

General accessories

Floorings / Interior decoration

	140.160	Pressure roller 1.6 inch with ball bearings (silicone)
	140.599	5 spare silicones
	140.161	Pressure roller 1.1 inch with ball bearings (silicone)
	140.598	5 spare silicones
	106.974	Pressure roller 3.1 inch (silicone)
	106.972	Pressure roller, with ball bearings (brass)
	106.976	Pressure roller 1.1 inch (PTFE)
	106.969	Spatula
	122.541	Trimming guide, to use with spatula (106.969)
	106.966	Hand grooving tool
	106.968	Spare blades for hand grooving tool
	137.855	Leister cutter with four blades
	138.902	10 x 10 spare blades hook shape
	138.539	10 x 10 spare blades trapezoid shape
	116.586	Storage case for TRIAC BT, TRIAC PID, TRIAC S, ELECTRON

Plastic fabrication

	107.348	Tool rest for TRIAC PID, TRIAC S
	137.855	Leister cutter with four blades
	138.902	10 x 10 spare blades hook shape
	138.539	10 x 10 spare blades trapezoid shape
	116.586	Storage case for TRIAC BT, TRIAC PID, TRIAC S, ELECTRON

Civil Engineering / Tunnel / Landfill sites

	140.160	Pressure roller 1.6 inch with ball bearings (silicone)
	140.599	5 spare silicones
	140.161	Pressure roller 1.1 inch with ball bearings (silicone)
	140.598	5 spare silicones
	106.976	Pressure roller 1.1 inch (PTFE)
	137.855	Leister cutter with four blades
	138.902	10 x 10 spare blades hook shape
	138.539	10 x 10 spare blades trapezoid shape
	116.586	Storage case for TRIAC BT, TRIAC PID, TRIAC S, ELECTRON